

Features

- Under-mount installation.
- With overflow.
- 19-7/16" (494 mm) x 16-1/16" (408 mm)

Material

- KOHLER® enameled cast iron.

Recommended Accessories

K-9018 P-Trap

Components

Additional included component/s: Hardware Kit.



ADA **CSA B651**

Codes/Standards











ASME A112.19.1/CSA B45.2
ADA
ICC/ANSI A117.1
CSA B651

Lifetime Limited Warranty for KOHLER® Cast Iron Components

See website for detailed warranty information.

Available Color/Finishes

Color tiles intended for reference only.

Color	Code	Description
	0	White
	FF	Sea Salt™
	96	Biscuit
	47	Almond
	FD	Cane Sugar™
	NY	Dune
	95	Ice™ Grey
	G9	Sandbar
	FT	Basalt
	J15	Greenwich Green
	20	Suede
	KA	Black 'n Tan
	7	Black Black™

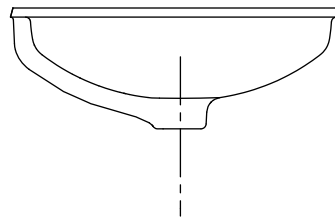
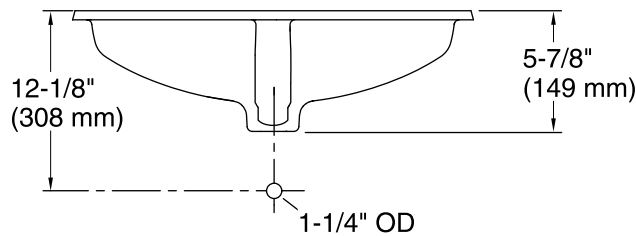
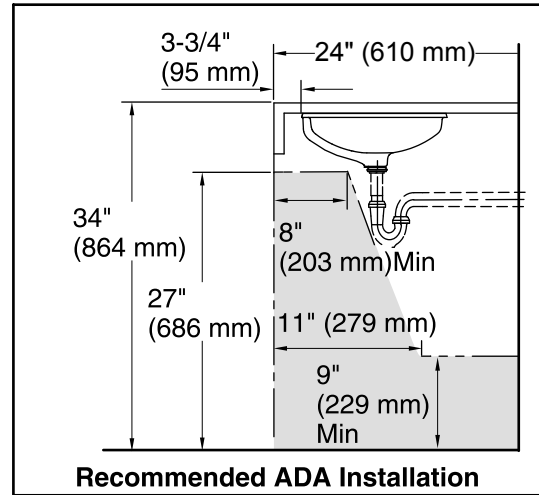
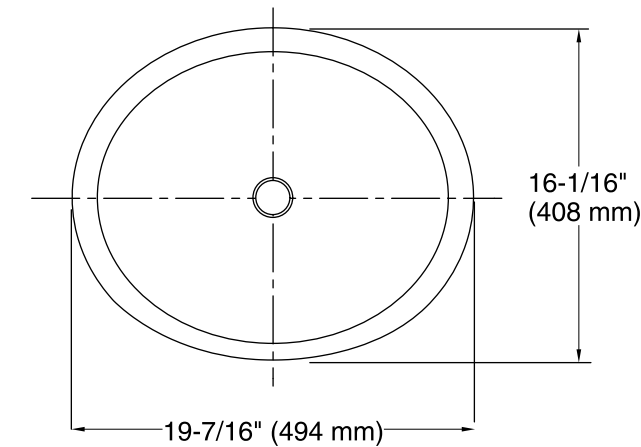

Technical Information

All product dimensions are nominal.

Installation:	Under-mount
Bowl area:	Length: 17" (432 mm) Width: 14" (356 mm) Bowl depth: 3-15/16" (100 mm) Water depth: 2-5/8" (67 mm)
Drain hole:	1-5/8" (41 mm)
Template:	1151011-7, required, included

Notes

Install this product according to the installation instructions.

NOTICE: Countertop manufacturer or cutter must use the current product template available at www.kohler.com, or by calling 1-800-4KOHLER. Kohler Co. is not responsible for cutout errors when the incorrect cutout template is used.

ADA, CSA B651 compliant when installed to the specific requirements of these regulations.